



*Neo fix*

**MADE IN KOREA**

THE SHOPFITTING CATALOGUE

CHANNELS | BRACKETS | HOOKS



## The Masterpiece of Store Fixtures

- Upright Channels
- Brackets & Hooks





Channels & Brackets



S-MARKET, Korea.



Channels & Brackets



EUROSHOP 2011.



ROGATIS Shop, Korea.



EUROSHOP 2017.



EUROSHOP 2020.

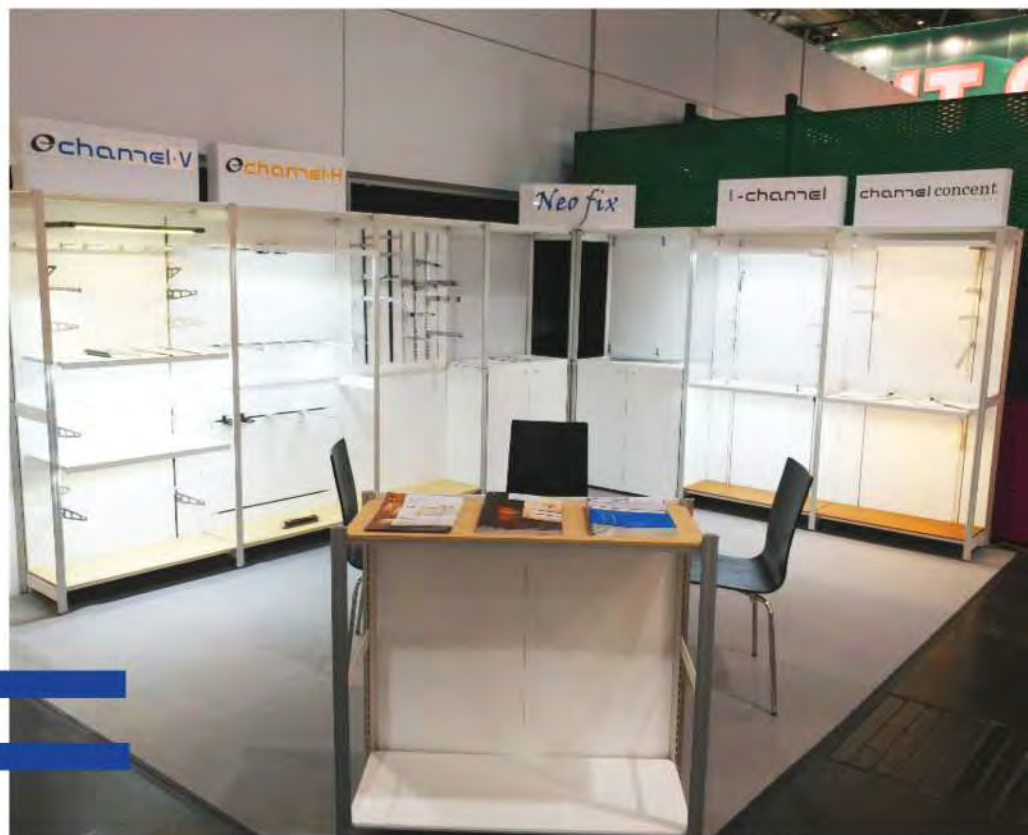

EUROSHOP 2020.



Wall Standards

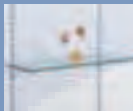

Brackets for Glass Shelves (유리선반용)

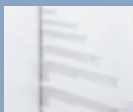

Brackets for Wooden Shelves (목 선반용)

Adjustable Brackets

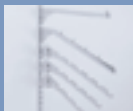

Face Out for Wall Standard



Hangrail Brackets

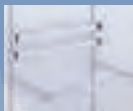

Rectangular Hangrail Brackets



Tubing

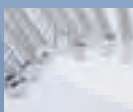

Tubing Cap



Hook for Tubings



Face Out

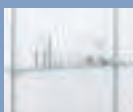
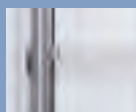

Accessories

2  
4  
7  
10  
11  
12  
14  
17  
19  
21  
22  
26

Slim and Elegant but Strong Features

# Wall Standards

## N-11

Single slotted slimline standards

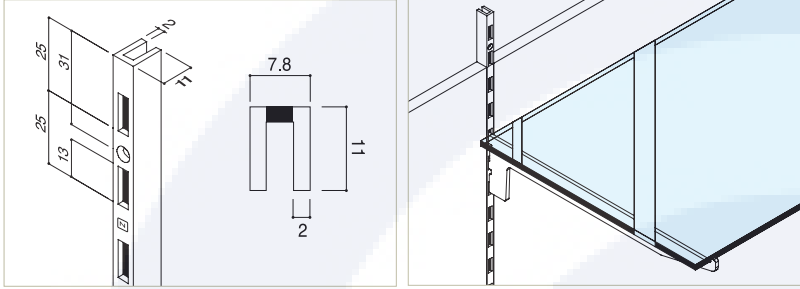

Most widely used standard. Flush-mountable. (주로 많이 쓰이는 채널)

Length(mm/inch)	Hole	Code	Quantity Per pack
600/23.62	3	71110	10
900/35.43	4	71111	10
1200/47.24	6	71112	10
1500/59.05	7	71113	10
1890/74.40	9	71114	10
2400/94.48	11	71115	10
3000/118.00	14	71116	10

## N-14

Single slotted slimline standards

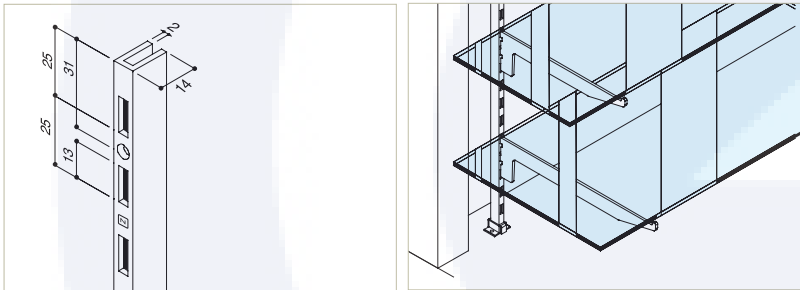

Suitable for wall & showcase applications. (벽체 매입 & 쇼케이스용 채널)

Length(mm/inch)	Hole	Code	Quantity Per pack
600/23.62	3	71210	10
900/35.43	4	71211	10
1200/47.24	6	71212	10
1500/59.05	7	71213	10
1890/74.40	9	71214	10
2400/94.48	11	71215	10
3000/118.00	14	71216	10

## N-6 다보용

Shelf standards

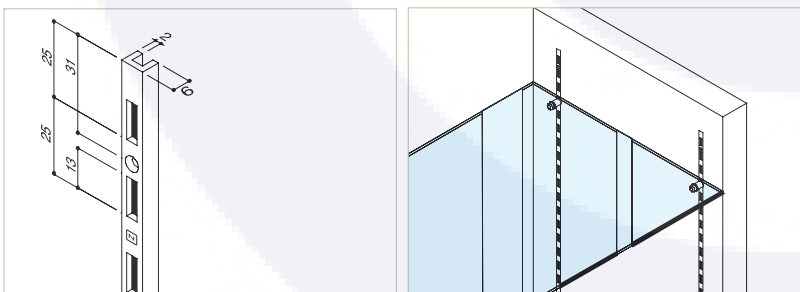

6 mm depth standards for shelf application. Suitable for wall furniture and bookstand. Use with N-61, N-62 (6mm 깊이 채널로 벽장 및 책장등의 용도로 N-61, N-62 다보와 함께 사용)

Length(mm/inch)	Hole	Code	Quantity Per pack
1200/47.24	6	71310	10
1500/59.05	7	71311	10
1890/74.40	9	71312	10
2400/94.48	11	71313	10
3000/118.00	14	71314	10

## N-112

Double slotted standards

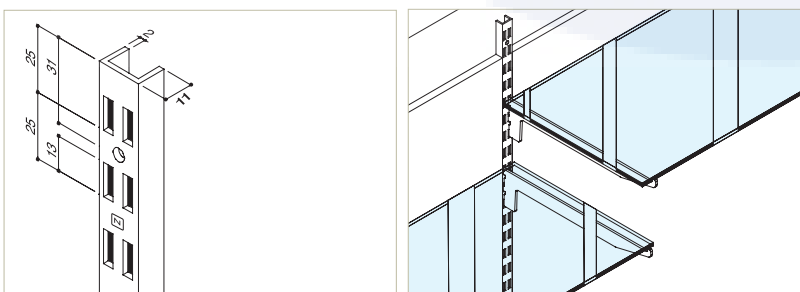

Applied to single or double brackets (싱글 및 더블로 실용적인 사용이 가능한 채널)

Length(mm/inch)	Hole	Code	Quantity Per pack
600/23.62	3	71120	10
900/35.43	4	71121	10
1200/47.24	6	71122	10
1500/59.05	7	71123	10
1890/74.40	9	71124	10
2400/94.48	11	71125	10
3000/118.00	14	71126	10



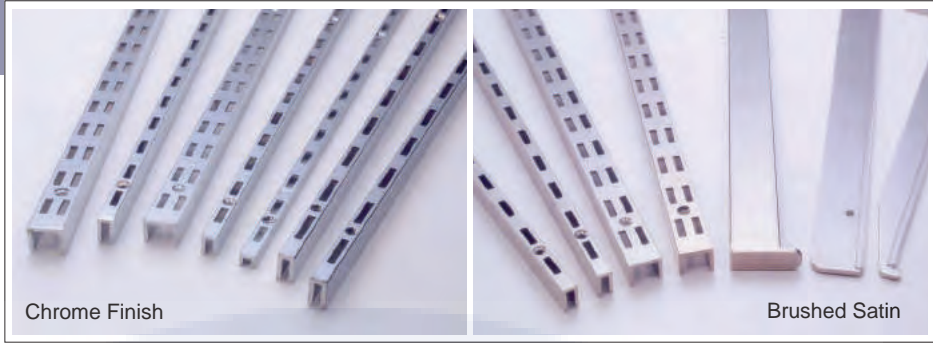

**N-142**

Double slotted standards

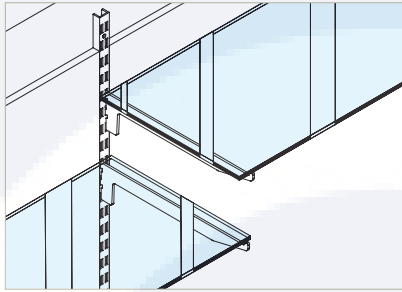
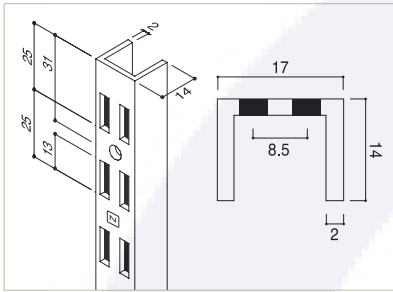

Applied to single or double brackets (싱글 및 더블로 실용적인 사용이 가능한 채널)

Length(mm/inch)	Hole	Code	Quantity Per pack
600/23.62	3	71220	10
900/35.43	4	71221	10
1200/47.24	6	71222	10
1500/59.05	7	71223	10
1890/74.40	9	71224	10
2400/94.48	11	71225	10
3000/118.00	14	71226	10

**NSI-1** 벽체매입채널

Recessed standards

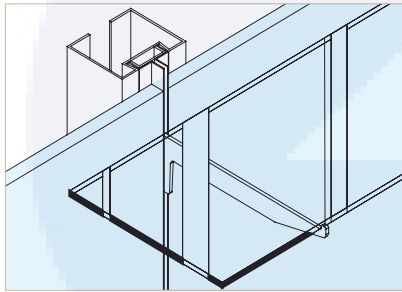
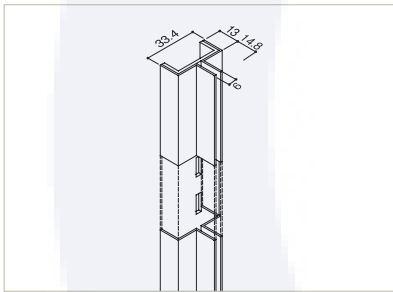

Length(mm/inch)	Hole	Code	Quantity Per pack
1800/70.86	10	71510	5
2400/94.48	12	71511	5

# Brackets for Glass Shelves

(유리선반용)

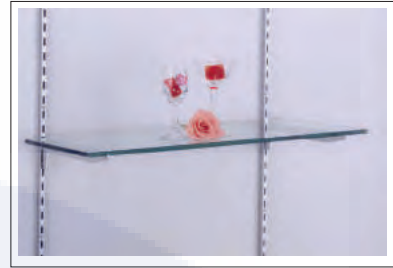

## NX-12

Glass shelf bracket with lip

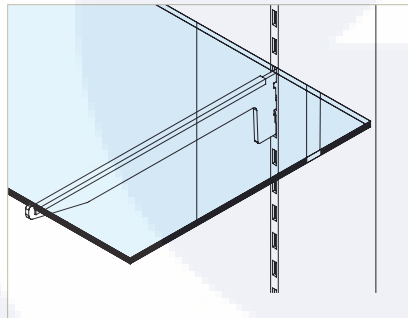
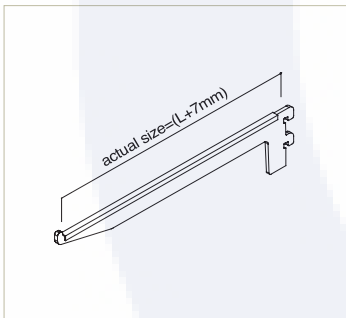

Supplied with a clear cushion rubber (유리선반용 날개로 투명고무를 끼워 유리선반 미끄럼을 방지)

Length(mm/inch)	Actual size	Code	Quantity Per carton
90/3.54	97	72110	10
120/4.72	127	72111	10
150/5.90	157	72112	10
180/7.08	187	72113	10
200/7.87	207	72114	10
210/8.26	217	72115	10
240/9.44	247	72116	10
250/9.84	257	72117	10
270/10.62	277	72118	10
300/11.81	307	72119	10
330/12.99	337	72120	10
350/13.77	357	72121	10

## NX-13

Glass shelf bracket with lip

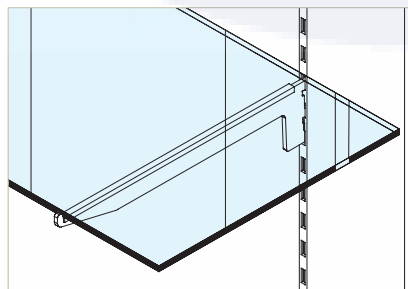
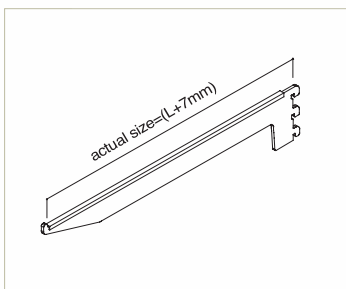

Supplied with a clear cushion strip (유리선반용 날개로 투명고무를 끼워 유리선반 미끄럼을 방지)

Length(mm/inch)	Actual size	Code	Quantity Per carton
270/10.62	277	72124	10
300/11.81	307	72125	10
330/12.99	337	72126	10
350/13.77	357	72127	10
400/15.74	407	72128	10
450/17.71	457	72129	10

**NX-122**

Glass shelf bracket in corner

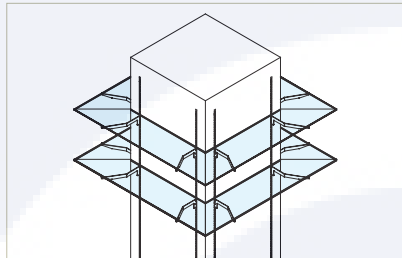
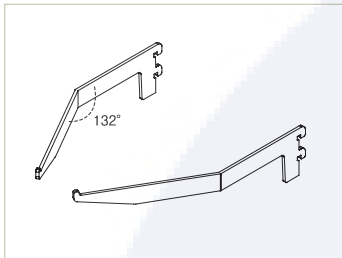

Supplied with a clear cushion strip (유리전용 날개로 투명고무를 끼워 유리선반 미끄럼을 방지)

Length(mm/inch)	Actual size	Code	Quantity Per carton
200/7.87	207	72130	10
250/9.84	257	72131	10
300/11.81	307	72132	10

**NX-132**

Glass shelf bracket in corner

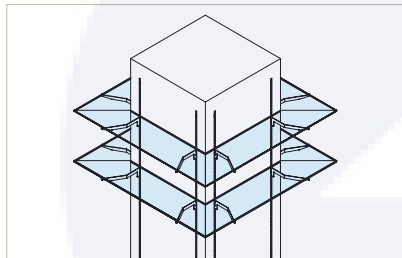
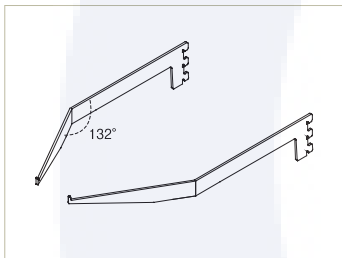

Supplied with a clear cushion strip (유리전용 날개로 투명고무를 끼워 유리선반 미끄럼을 방지)

Length(mm/inch)	Actual size	Code	Quantity Per carton
300/11.81	307	72133	10
350/13.77	357	72134	10
400/15.74	407	72135	10

**NX-142 L, R**

Glass shelf bracket with lip

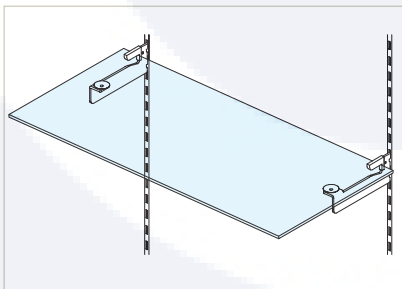
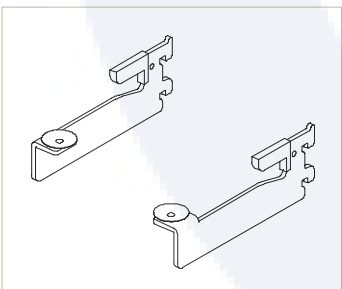

Supplied with a clear cushion rubber (유리전용 날개로 투명고무를 끼워 유리선반 미끄럼을 방지)  
Use with 8T glass shelf

Length(mm/inch)	Actual size	Code	Quantity Per carton
120/4.7	127	C012999	5+5

**NX-22**

Glass shelf bracket

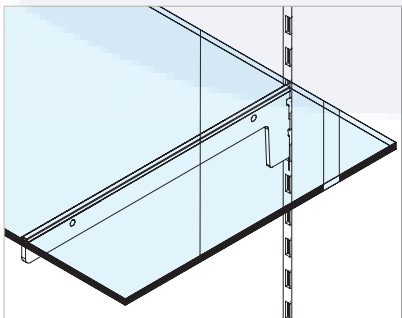
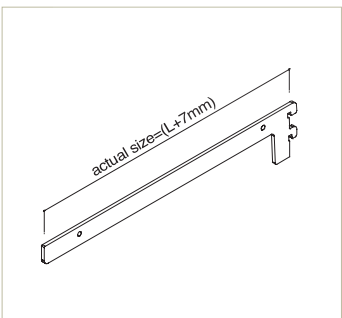

Supplied with a clear cushion strip (유리전용 날개로 투명고무를 끼워 유리선반 미끄럼을 방지)

Length(mm/inch)	Actual size	Code	Quantity Per carton
100/3.93	107	72210	10
120/4.72	127	72211	10
150/5.90	157	72212	10
180/7.08	187	72213	10
200/7.87	207	72214	10
210/8.26	217	72215	10
240/9.44	247	72216	10
250/9.84	257	72217	10
270/10.62	277	72218	10
300/11.81	307	72219	10
330/12.99	337	72220	10
350/13.77	357	72221	10

### NX-23

Glass shelf bracket

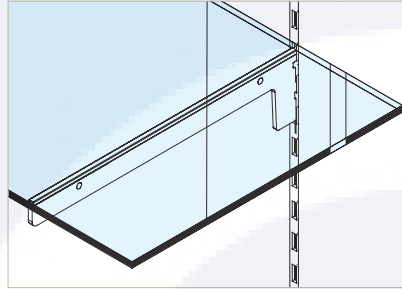
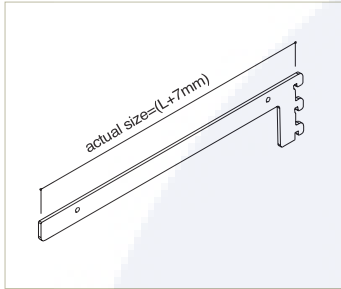

Length(mm/inch)	Actual size	Code	Quantity Per carton
270/10.62	277	72225	10
300/11.81	307	72226	10
330/12.99	337	72227	10
350/13.77	357	72228	10
400/15.74	407	72229	10
420/16.53	427	72230	10

Supplied with a clear cushion strip (유리전용 날개로 투명고무를 끼워 유리선반 미끄럼을 방지)  
for heavy weight

### NX-24

Glass shelf bracket - for heavy weight

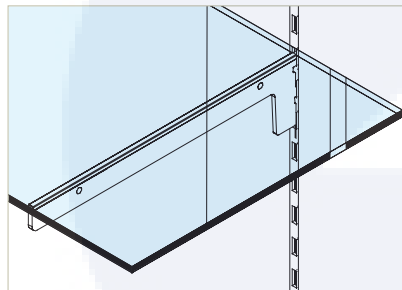
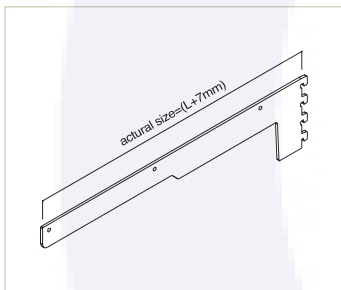

Length(mm/inch)	Actual size	Code	Quantity Per carton
400/15.74	407	72235	10
420/16.53	427	72236	10
450/17.71	457	72237	10
500/19.68	507	72238	10
550/21.65	557	72239	10

Supplied with a clear cushion strip (유리전용 날개로 투명고무를 끼워 유리선반 미끄럼을 방지)

### NX-222

Glass shelf bracket in corner

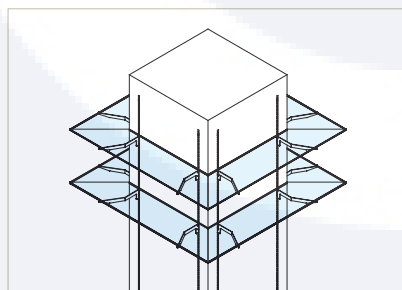
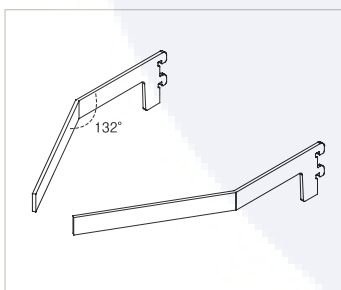

Length(mm/inch)	Actual size	Code	Quantity Per carton
200/7.87	207	72240	10
250/9.84	257	72241	10
300/11.81	307	72242	10

Supplied with a clear cushion strip (유리전용 날개로 투명고무를 끼워 유리선반 미끄럼을 방지)

### NX-232

Glass shelf bracket in corner

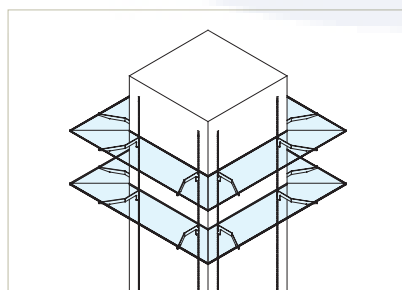
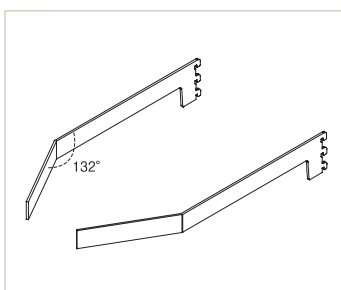

Length(mm/inch)	Actual size	Code	Quantity Per carton
300/11.81	307	72243	10
350/13.77	357	72244	10

Supplied with a clear cushion strip (유리전용 날개로 투명고무를 끼워 유리선반 미끄럼을 방지)

지)

Neo fix

# Brackets for Wooden Shelves

(목선반용)



## NX-412 L, R

Wooden shelf bracket

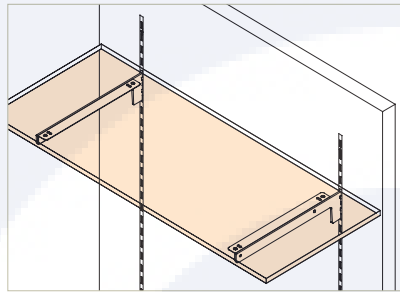
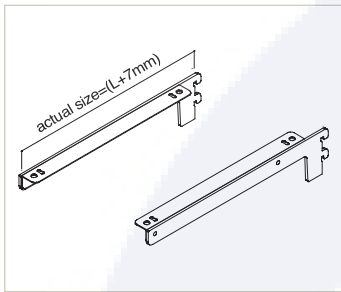

Length(mm/inch)	Actual size	Code	Quantity Per carton
100/3.93	107	73110	5+5
120/4.72	127	73111	5+5
150/5.90	157	73112	5+5
180/7.08	187	73113	5+5
200/7.87	207	73114	5+5
210/8.26	217	73115	5+5
240/9.44	247	73116	5+5
250/9.84	257	73117	5+5
270/10.62	277	73118	5+5
300/11.81	307	73119	5+5
330/12.99	337	73120	5+5
350/13.77	357	73121	5+5

## NX-413 L, R

Wooden shelf bracket

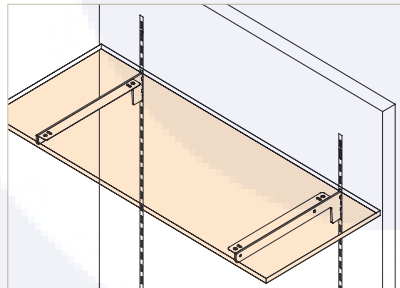
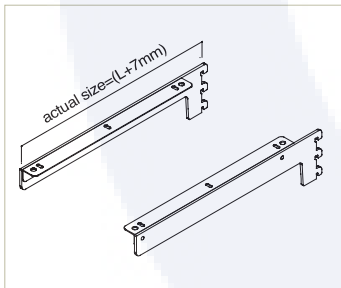

Length(mm/inch)	Actual size	Code	Quantity Per carton
270/10.62	277	73125	5+5
300/11.81	307	73126	5+5
330/12.99	337	73127	5+5
350/13.77	357	73128	5+5
400/15.74	407	73129	5+5
420/16.53	427	73130	5+5

## NX-414 L, R

Wooden shelf bracket

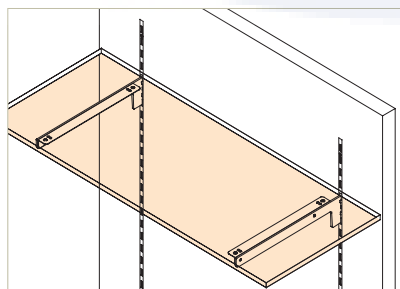
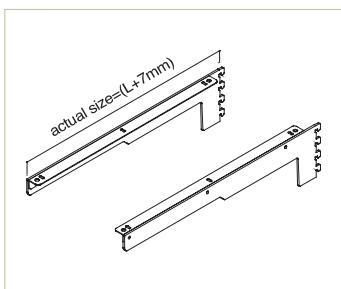

Length(mm/inch)	Actual size	Code	Quantity Per carton
400/15.74	407	73135	5+5
420/16.53	427	73136	5+5
450/17.71	457	73137	5+5
500/19.68	507	73138	5+5
550/21.65	557	73139	5+5

For heavy weight

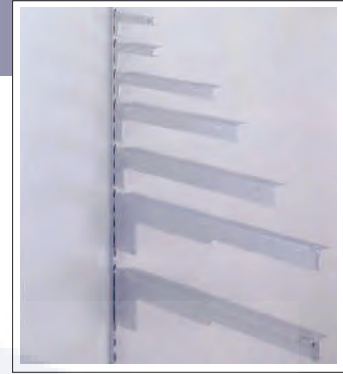

### NX-422 C

Wooden shelf bracket

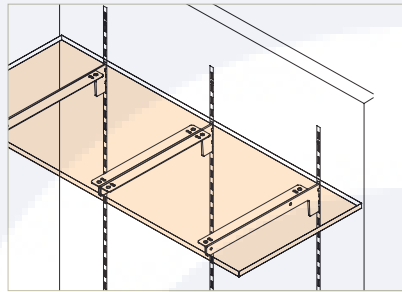
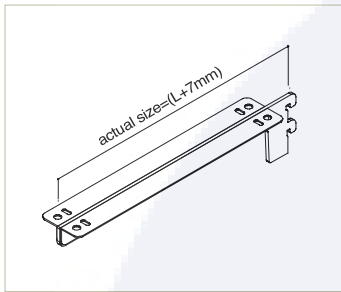

Length(mm/inch)	Actual size	Code	Quantity Per carton
100/3.93	107	75110	5
120/4.72	127	75111	5
150/5.90	157	75112	5
180/7.08	187	75113	5
200/7.87	207	75114	5
210/8.26	217	75115	5
240/9.44	247	75116	5
250/9.84	257	75117	5
270/10.62	277	75118	5
300/11.81	307	75119	5
330/12.99	337	75120	5
350/13.77	357	75121	5

### NX-423 C

Wooden shelf bracket

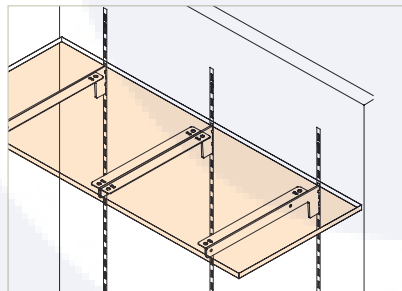
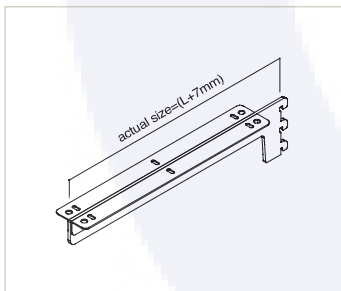

Length(mm/inch)	Actual size	Code	Quantity Per carton
270/10.62	277	75125	5
300/11.81	307	75126	5
330/12.99	337	75127	5
350/13.77	357	75128	5
400/15.74	407	75129	5
420/16.53	427	75130	5

### NX-424 C

Wooden shelf bracket

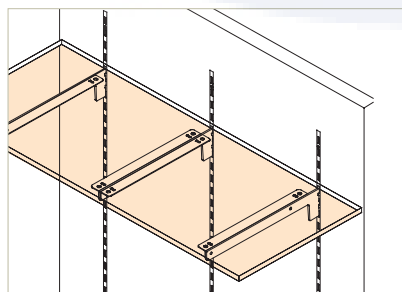
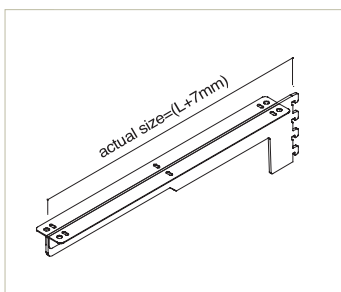

Length(mm/inch)	Actual size	Code	Quantity Per carton
400/15.74	407	75135	5
420/16.53	427	75136	5
450/17.71	457	75137	5
500/19.68	507	75138	5
550/21.65	557	75139	5

For heavy weight

### NX-432 L, R

Wooden shelf bracket

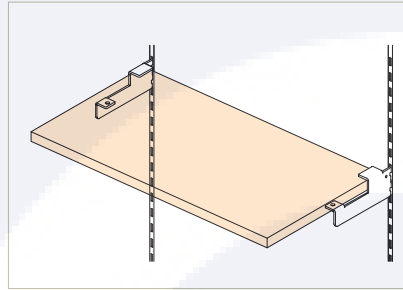
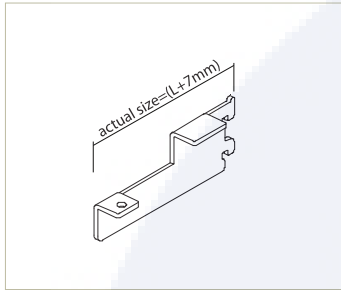

Use with 18T Wooden shelf

Length(mm/inch)	Actual size	Code	Quantity Per carton
120/4.7	127	C013000	5+5

### NX-443 L, R

Wooden shelf bracket

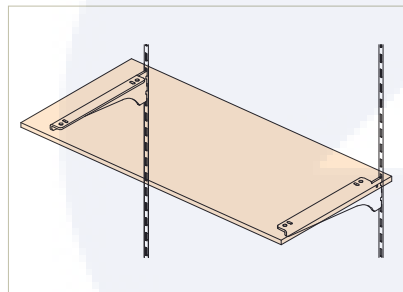
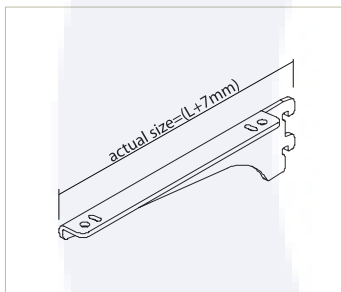

Length(mm/inch)	Actual size	Code	Quantity Per carton
150/5.90	157	75200	5+5
200/7.87	207	75201	5+5
250/9.84	257	75202	5+5
300/11.81	307	75203	5+5
350/13.77	357	75204	5+5
400/15.74	407	75205	5+5
450/17.71	457	75206	5+5

### NX-443D L, R

Wooden shelf bracket

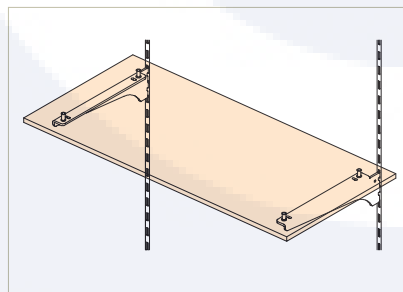
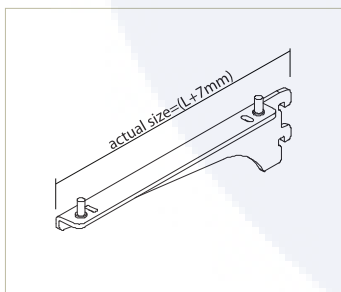

Length(mm/inch)	Actual size	Code	Quantity Per carton
150/5.90	157	75210	5+5
200/7.87	207	75211	5+5
250/9.84	257	75212	5+5
300/11.81	307	75213	5+5
350/13.77	357	75214	5+5
400/15.74	407	75215	5+5
450/17.71	457	75216	5+5

### NX-453 L, R

Wooden shelf bracket

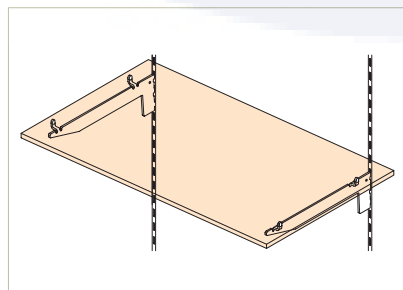
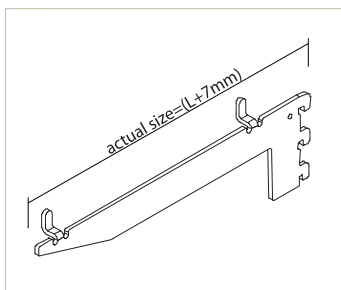

Length(mm/inch)	Actual size	Code	Quantity Per carton
250/9.84	257	C012913	10+10
300/11.81	307	C012914	10+10
350/13.77	357	C012915	10+10
400/15.74	407	C012916	10+10

# Adjustable Brackets

## NX-812

Adjustable bracket for glass shelf

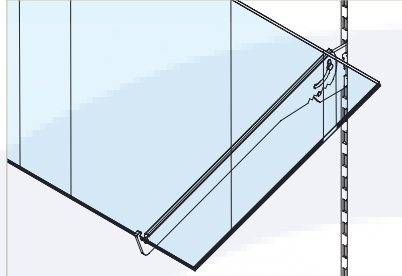
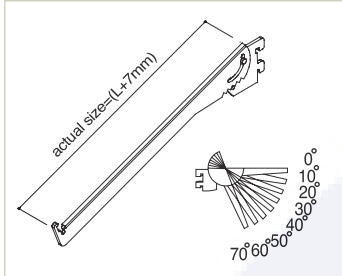

Supplied with a clear cushion strip (유리전용 날개로 투명고무를 끼워 유리선반 미끄럼을 방지)

Length(mm/inch)	Actual size	Code	Quantity Per carton
150/5.90	157	78114	10
180/7.08	187	78115	10
200/7.87	207	78110	10
250/9.84	257	78111	10
300/11.81	307	78112	10
350/13.77	357	78113	10

## NX-822

Adjustable bracket for glass shelf

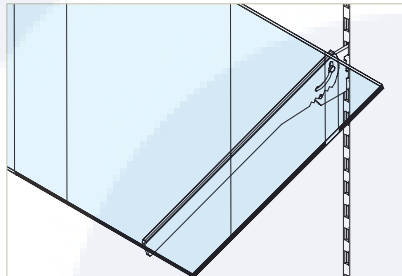
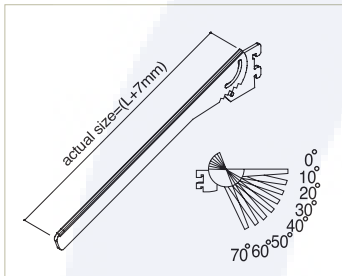

Supplied with a clear cushion strip (유리전용 날개로 투명고무를 끼워 유리선반 미끄럼을 방지)

Length(mm/inch)	Actual size	Code	Quantity Per carton
200/7.87	207	78210	10
250/9.84	257	78211	10
300/11.81	307	78212	10
350/13.77	357	78213	10

## NX-832 L, R

Adjustable bracket for wooden shelf

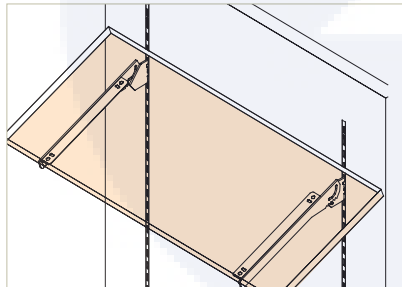
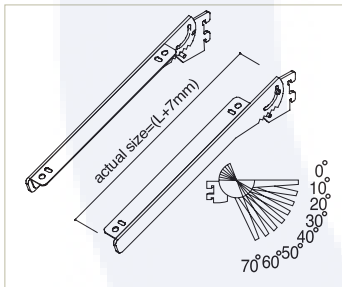

Length(mm/inch)	Actual size	Code	Quantity Per carton
200/7.87	207	78310	5+5
250/9.84	257	78311	5+5
300/11.81	307	78312	5+5
350/13.77	357	78313	5+5

## NX-832 C

Adjustable bracket for wooden shelf

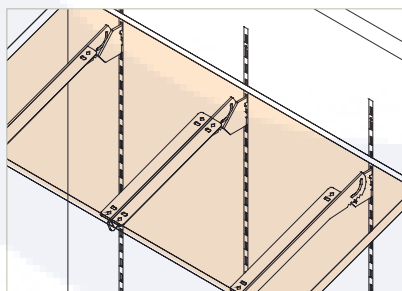
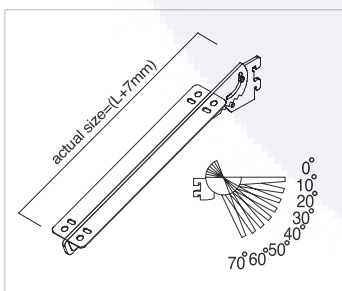

Length(mm/inch)	Actual size	Code	Quantity Per carton
200/7.87	207	78510	5
250/9.84	257	78511	5
300/11.81	307	78512	5
350/13.77	357	78513	5



# Face Out for Wall Standard



## NX-842

Adjustable bracket for hanger

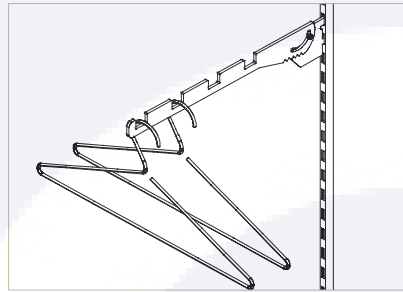
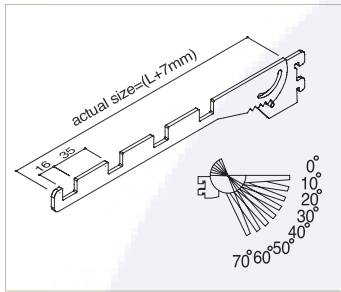

Length(mm/inch)	Actual size	Code	Quantity Per carton
200/7.87	207	78410	10
250/9.84	257	78411	10
300/11.81	307	78412	10
350/13.77	357	78413	10

## NP-02

5 Pins sloping hook for standards

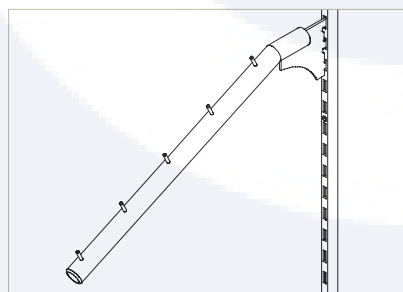
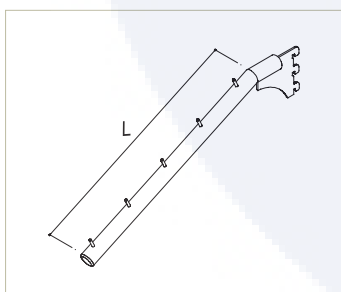

Length(mm/inch)	Diameter	Code	Quantity Per carton
330/12.99	Ø19	80038	50

## NP-03

Rectangular straight hook for standards

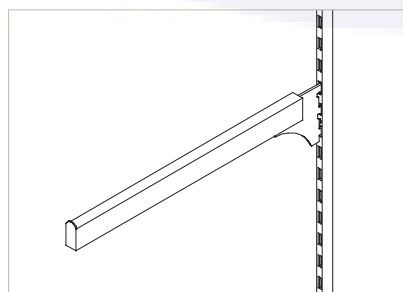
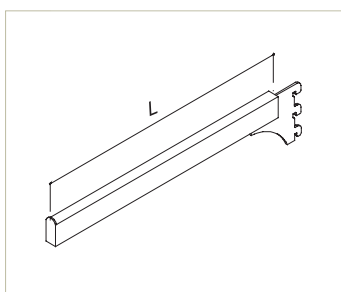

Length(mm/inch)	Size	Code	Quantity Per carton
250/9.84	12.7×25.5	80035	50
300/11.81	12.7×25.5	80036	50

# Hangrail Brackets

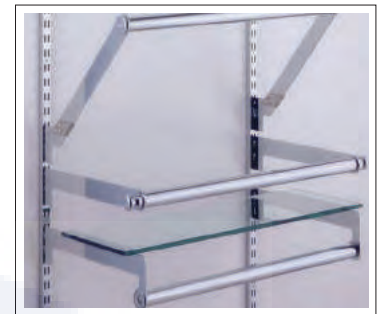

## NX-513

Bracket for round tubing Ø25 mm

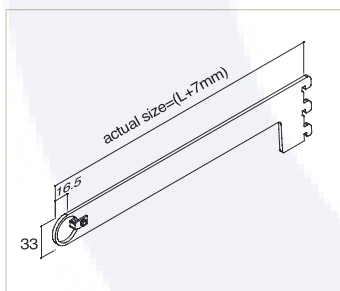

Use with HP-5, HP-50

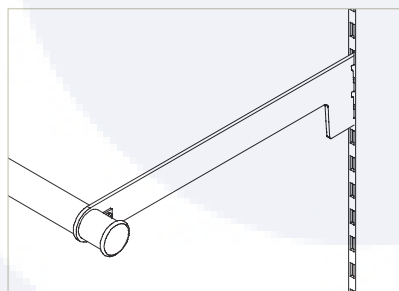

Length(mm/inch)	Actual size	Code	Quantity Per carton
50/1.96 (2 lugs)	57	76110	10
50/1.96	57	76119	10
70/2.75	77	76111	10
100/3.93	107	76112	10
150/5.90	157	76113	10
200/7.87	207	76114	10
250/9.84	257	76115	10
270/10.62	277	76116	10
300/11.81	307	76117	10
350/13.77	357	76118	10

## NX-523

Bracket for round tubing Ø25 mm

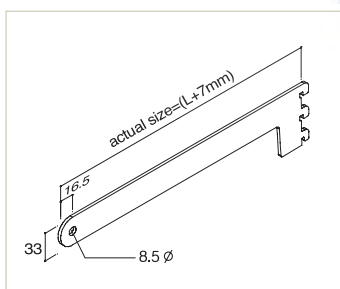

Use with HP-5, HP-51, HP-70

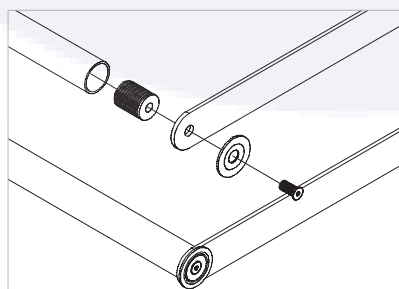

Length(mm/inch)	Actual size	Code	Quantity Per carton
50/1.96 (2 lugs)	57	76210	10
50/1.96	57	76219	10
70/2.75	77	76211	10
100/3.93	107	76212	10
150/5.90	157	76213	10
200/7.87	207	76214	10
250/9.84	257	76215	10
270/10.62	277	76216	10
300/11.81	307	76217	10
350/13.77	357	76218	10

### NX-533

Bracket for round tubing Ø25 mm & glass shelf

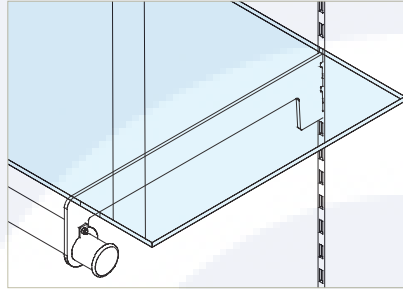
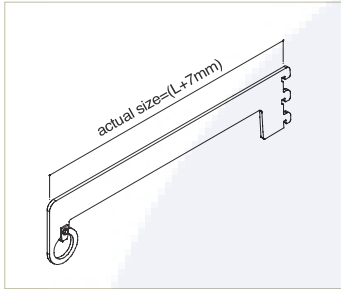

Length(mm/inch)	Actual size	Code	Quantity Per carton
250/9.84	257	76309	10
300/11.81	307	76310	10

Supplied with a clear cushion strip(유리전용 날개로 투명고무를 끼워 유리선반 미끄럼을 방지)  
Use with HP-5, HP-50, RSS-11

### NX-543

Bracket for round tubing Ø25 mm & glass shelf

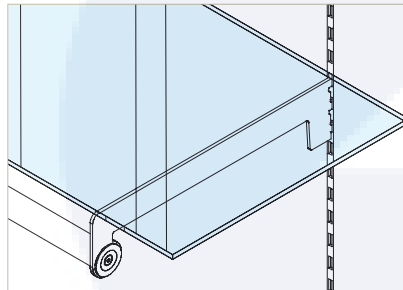
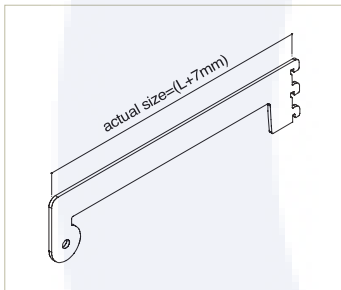

Length(mm/inch)	Actual size	Code	Quantity Per carton
250/9.84	257	76412	10
300/11.81	307	76410	10

Supplied with a clear cushion strip(유리전용 날개로 투명고무를 끼워 유리선반 미끄럼을 방지)  
Use with HP-5,HP-51,HP-70

### NX-552

25 mm round tubing supports

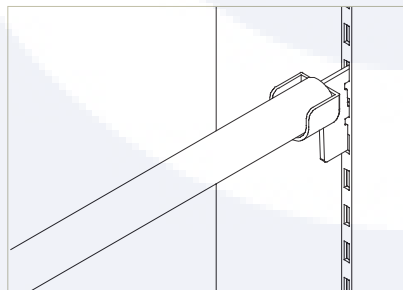
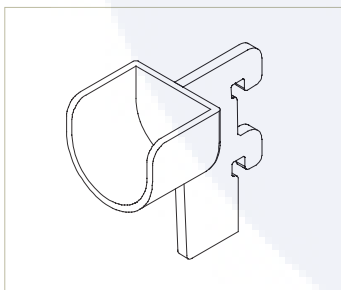

Length(mm/inch)	Actual size	Code	Quantity Per carton
50/1.96	50	76510	10

Use with HP-5

# Rectangular Hangrail Brackets



## NX-613

Bracket for rectangular tubing 15 x 25mm

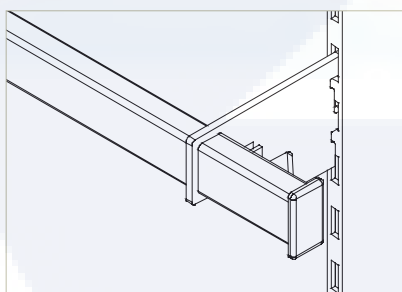
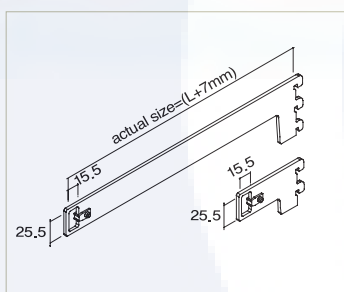

Use with HP-6

Length(mm/inch)	Actual size	Code	Quantity Per carton
50/1.96 (2 lugs)	57	77110	20
50/1.96	57	77119	20
70/2.75	77	77111	10
100/3.93	107	77112	10
150/5.90	157	77113	10
200/7.87	207	77114	10
250/9.84	257	77115	10
270/10.62	277	77116	10
300/11.81	307	77117	10
330/12.99	337	77118	10

## NX-623

Bracket for rectangular tubing 15 x 25mm

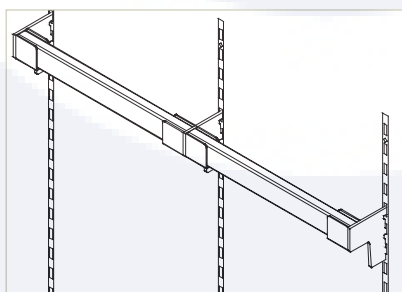
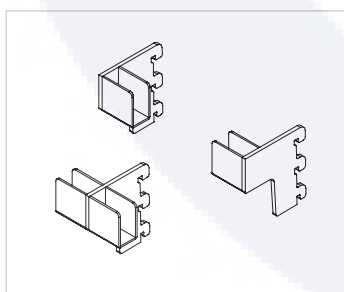

Use with HP-6

Length(mm/inch)	Actual size	Code	Quantity Per carton
NX-623 L, R		77210	5+5
NX-623 C		77211	10

## NX-624

Bracket for rectangular tubing 14 x 24mm

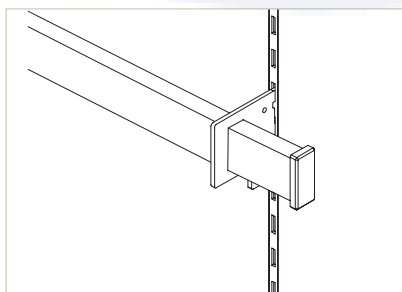
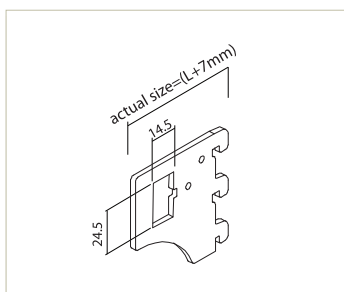

Use with HP-4

Length(mm/inch)	Actual size	Code	Quantity Per carton
50/1.96	57	81111	20
100/3.93	107	81112	20
150/5.90	157	81113	20
200/7.87	207	81114	20
250/9.84	257	81115	20
300/11.81	307	81116	20

# NX-632

Bracket for rectangular tubing 14 x 32mm

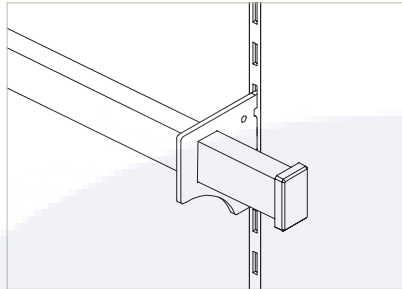
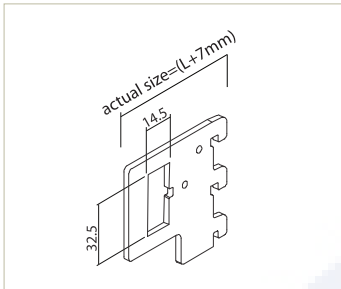

Length(mm/inch)	Actual size	Code	Quantity Per carton
50/1.96	57	81110	20
100/3.93	107	81117	20
150/5.90	157	81118	20
200/7.87	207	81119	20
250/9.84	257	81120	20
300/11.81	307	81121	20

Use with HP-8

Welding Bracket (용접용 브라켓)

NE-11

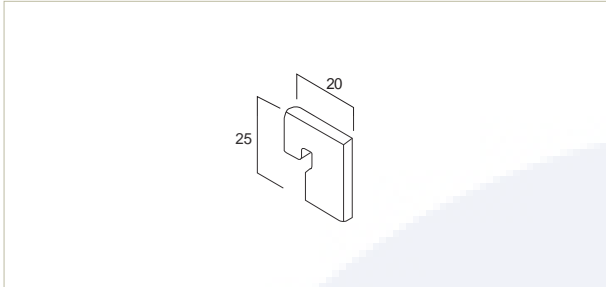

Item no	Size	Code	Quantity Per carton
NE-11	25 x 10	C003982	-

NE-21

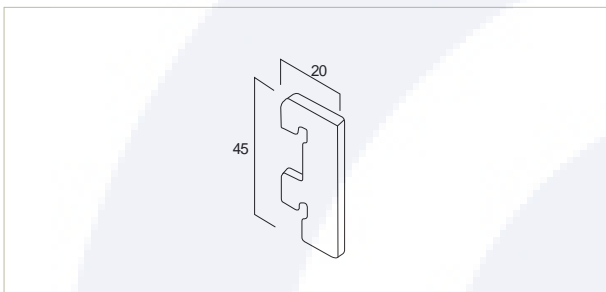

Item no	Size	Code	Quantity Per carton
NE-21	45 x 10	C003983	-

NE-31

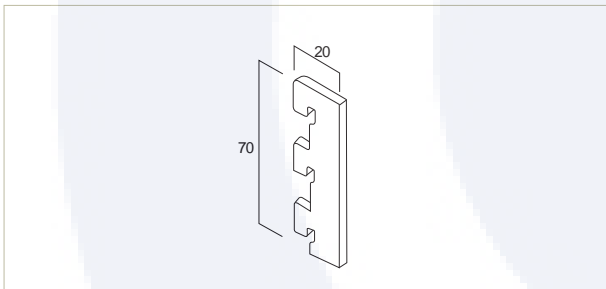

Item no	Size	Code	Quantity Per carton
NE-31	70 x 10	C003984	-

NE-33

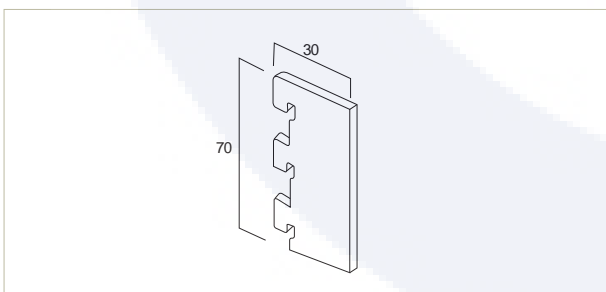

Item no	Size	Code	Quantity Per carton
NE-33	70 x 30	C003985	-

NE-34

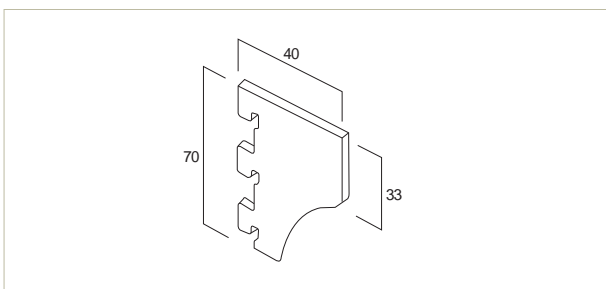

Item no	Size	Code	Quantity Per carton
NE-34	70 x 40	C003986	-

# Tubing



## HP-5

Round tubing Ø 25mm

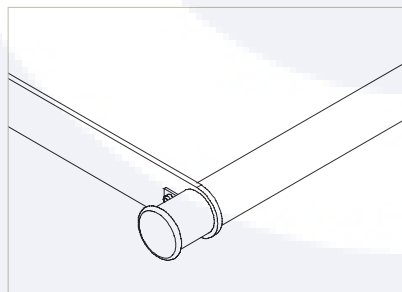
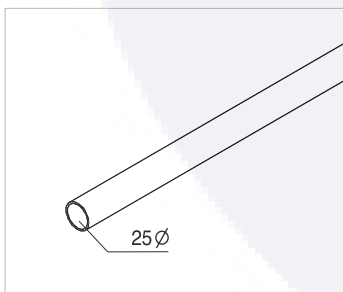

Length(mm/inch)	Actual size	Code	Quantity Per pack
1000/39.37	1000	79110	5
1200/47.24	1200	79111	5
1500/59.05	1500	79112	5
1800/74.40	1800	79113	5
2000/78.74	2000	79114	5

Use with NX-513, NX-523, NX-533, NX-543, NX-552, NX-563, HP-50

## HP-4

Rectangular tubing 14 x 24mm

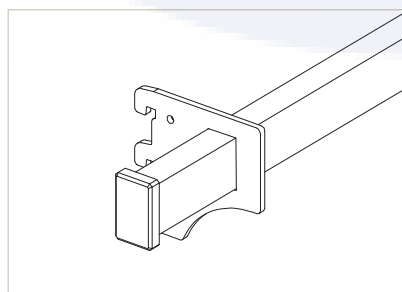
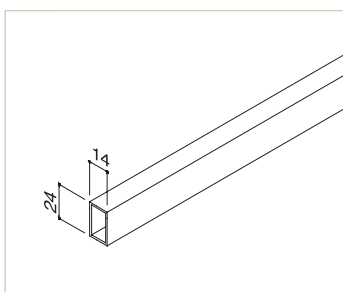

Length(mm/inch)	Actual size	Code	Quantity Per pack
900/35.43	900	81410	5
1200/47.24	1200	81411	5
1500/59.05	1500	81412	5
1800/74.40	1800	81413	5
2100/82.67	2100	81414	5

Use with NX-624, HP-40, HP-41

## HP-6

Rectangular tubing 15 x 25mm

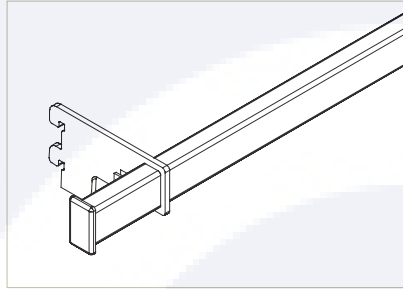
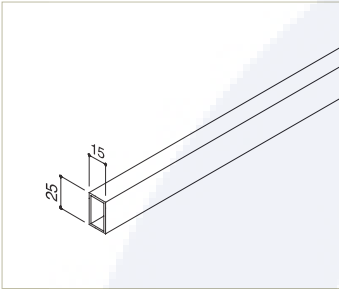

Use with NX-613, NX-623, NX-633, NX-652, HP-60, HP-61

Length(mm/inch)	Actual size	Code	Quantity Per pack
1000/39.37	1000	79210	5
1200/47.24	1200	79211	5
1500/59.05	1500	79212	5
1800/74.40	1800	79213	5
2000/78.74	2000	79214	5

## HP-8

Rectangular tubing 14 x 32mm

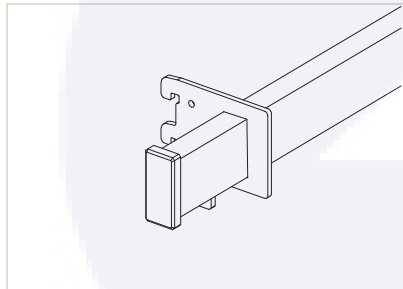
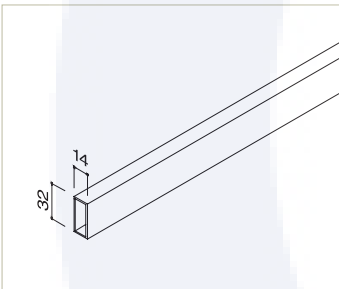

Use with NX-632, HP-80, HP-81

Length(mm/inch)	Actual size	Code	Quantity Per pack
1000/39.37	1000	81510	5
1200/47.24	1200	81511	5
1500/59.05	1500	81512	5
1800/74.40	1800	81513	5
2000/78.74	2000	81514	5





# Tubing Cap



## HP-40

Rectangular tubing cap for 14 x 24mm

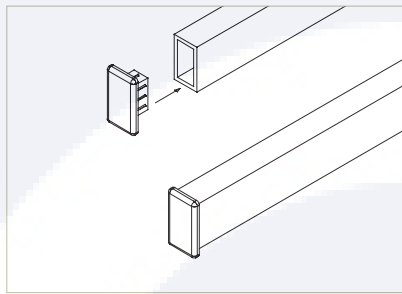
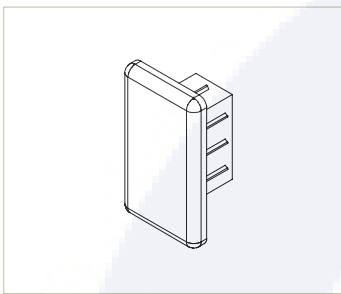

Length(mm/inch)		Code	Quantity Per carton
14 x 24		81611	50

## HP-41

Rectangular tubing cap for 14 x 24mm

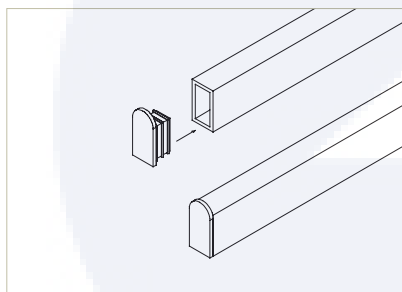
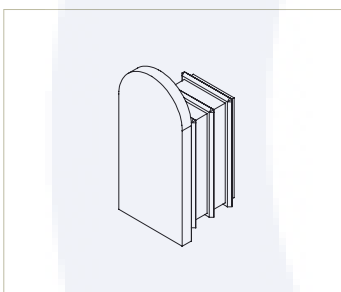

Length(mm/inch)		Code	Quantity Per carton
14 x 24		81612	50

## HP-50

Round tubing cap for 25mm

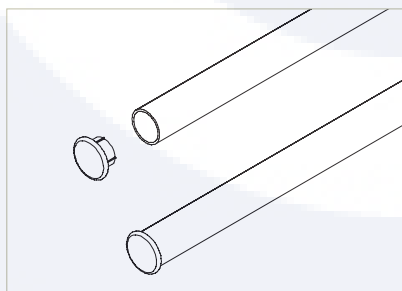
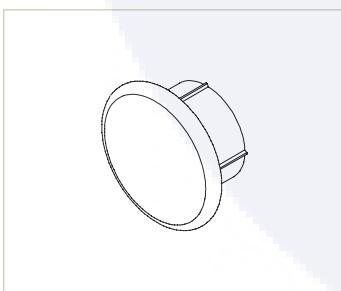

Available Tube Diameter		Code	Quantity Per carton
Ø25		79120	50

## HP-51

Hanging tools

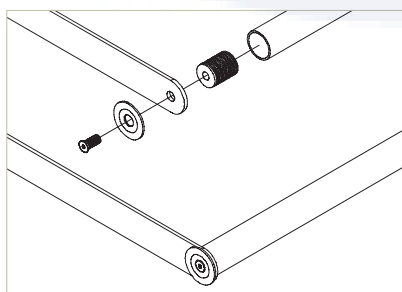
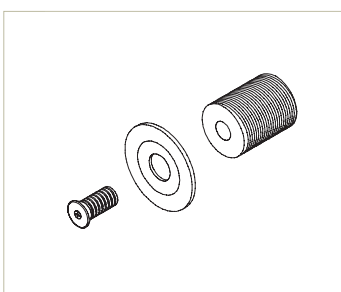

Available Tube Diameter		Code	Quantity Per carton
Ø25		79122	10

**HP-60**

Rectangular tubing cap for 15 x 25mm

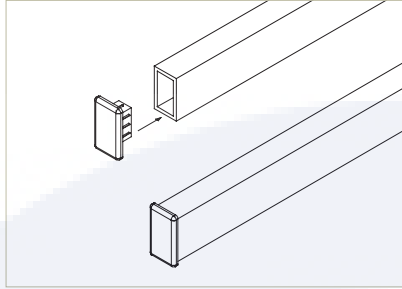
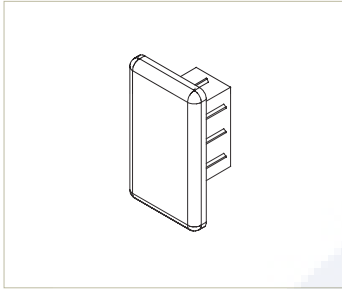

Available Tube Diameter	Head Diameter	Code	Quantity Per carton
15 x 25	20 x 30	79220	50

**HP-61**

Rectangular tubing cap for 15 x 25mm

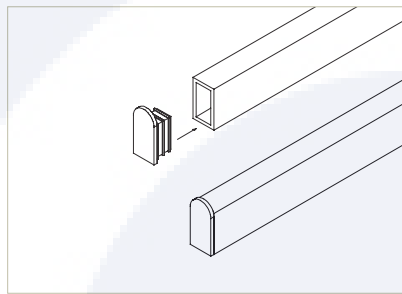
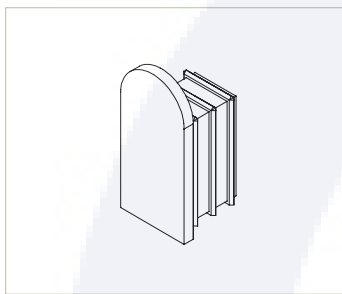

Length(mm/inch)		Code	Quantity Per carton
15 x 25		C013001	50

**HP-80**

Rectangular tubing cap for 14 x 32mm

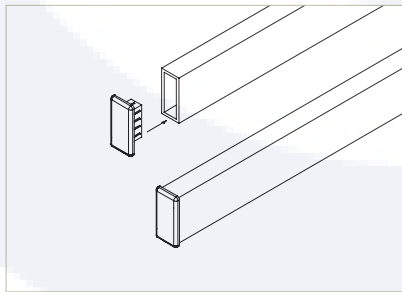
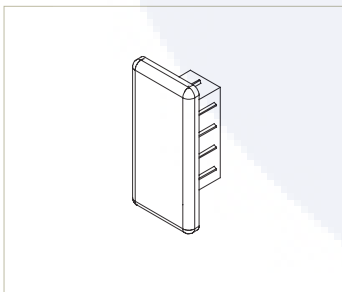

Tube Size	Head Diameter	Code	Quantity Per carton
14 x 32	14.5x32.5	81621	50

**HP-81**

Rectangular tubing fashion cap for 14 x 32mm

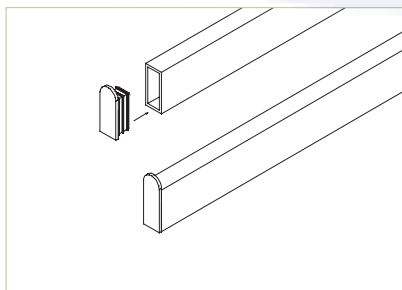
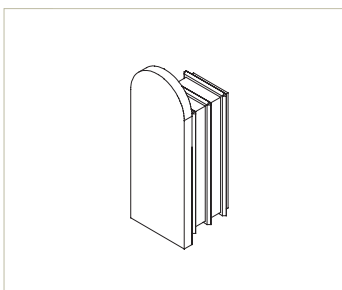

Tube Size	Head Diameter	Code	Quantity Per carton
14 x 32	14.2x40	81622	50

# Hook for Tubings



## HP-82

Single line hook

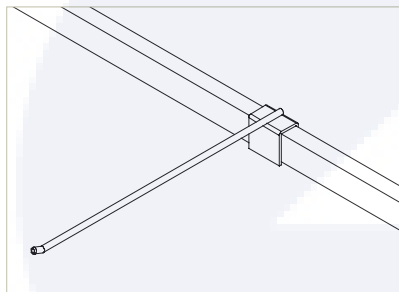
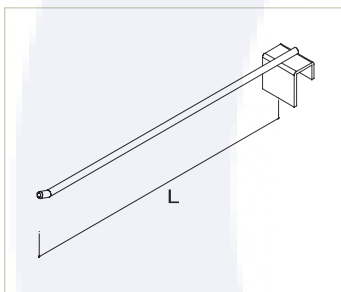

For the use with tubings 14 x 32mm, 14 x 24mm tubings

Length(mm/inch)	Diameter	Code	Quantity Per carton
50/1.96	Ø6	80010	100
100/3.93	Ø6	80011	100
150/5.90	Ø6	80012	100
200/7.87	Ø6	80013	100
250/9.84	Ø6	80014	100
300/11.81	Ø6	80015	100
350/13.77	Ø6	80016	100

## HP-84

Double line hook

Price tag included

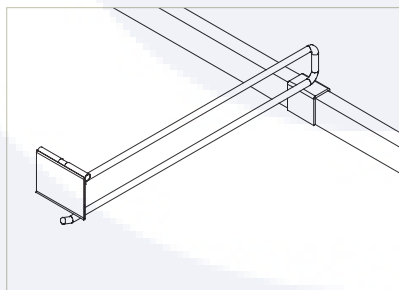
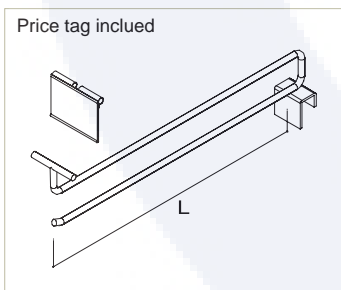

For the use with tubings 14 x 32mm, 14 x 24mm

Length(mm/inch)	Diameter	Code	Quantity Per carton
150/5.90	Ø6	80020	100
200/7.87	Ø6	80021	100
250/9.84	Ø6	80022	100
300/11.81	Ø6	80023	100
300/11.81	Ø6	80024	100
350/13.77	Ø6	80025	100

## HP-85

8 Columns hook

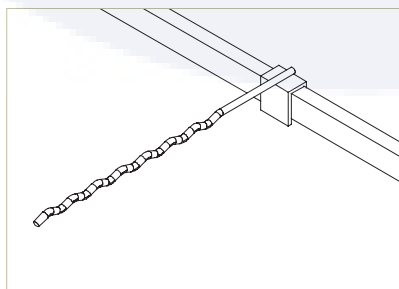
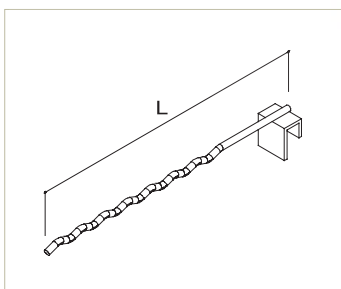

For the use with tubings 14 x 32mm

Length(mm/inch)	Diameter	Code	Quantity Per carton
300/11.81		80034	100

# Face Out For Tubings

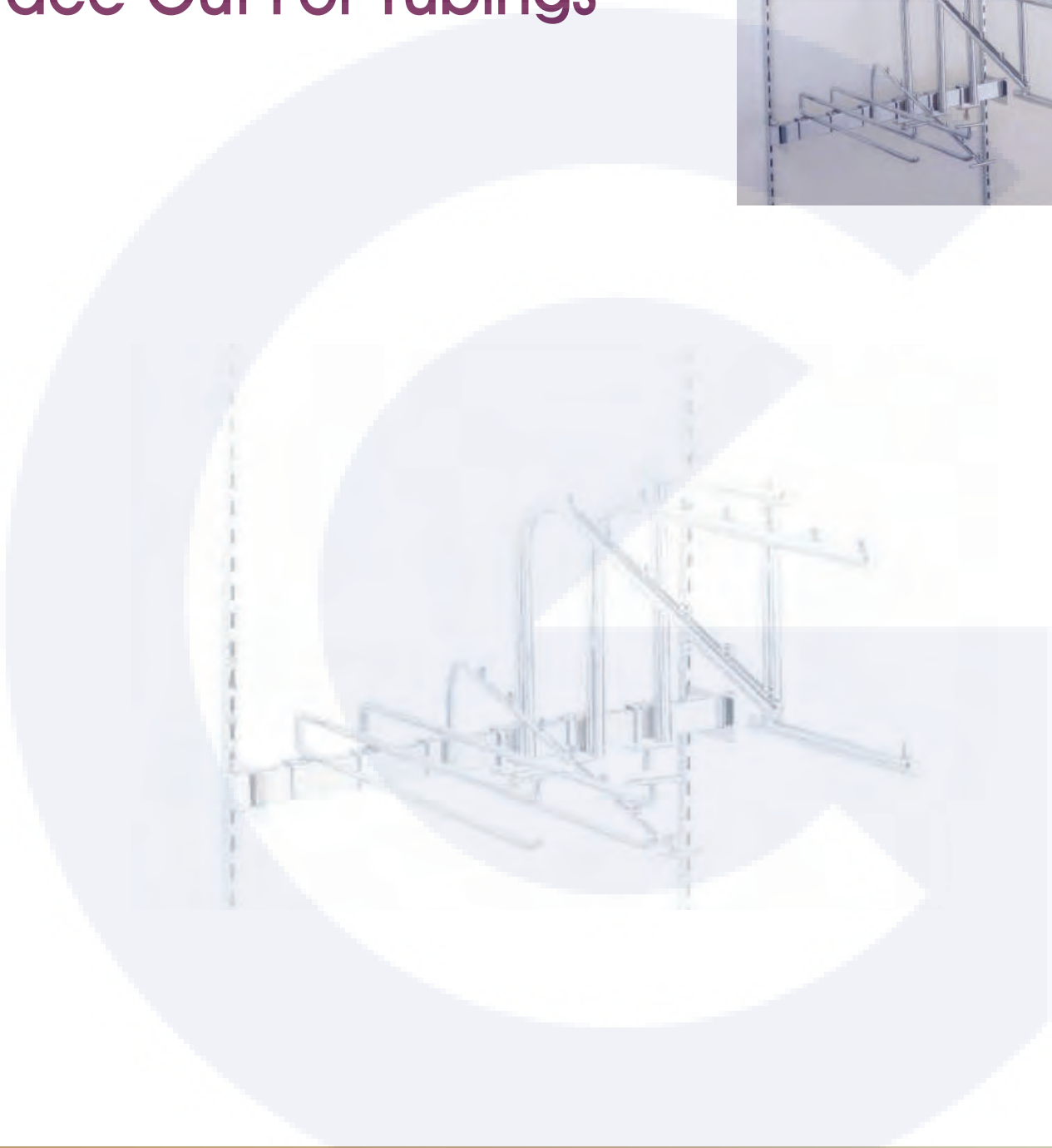

**HP-47**

Straight hook for rectangular tube 14x24

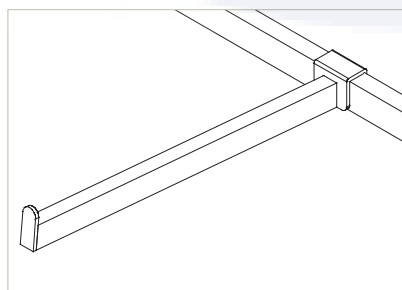
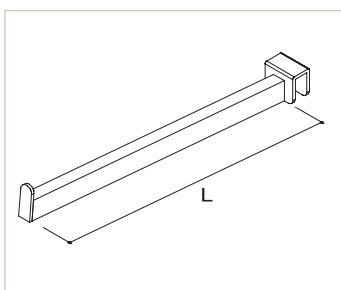

Length(mm/inch)	Size	Code	Quantity Per carton
250/9.84	12.8x25.5	80044	25
300/11.81	12.8x25.5	80045	25

**HP-48**

6 Pin slopping hook for rectangular tube

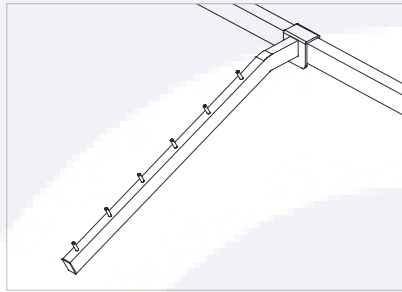
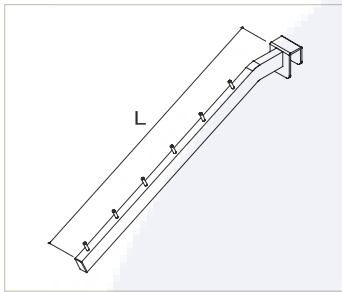

Length(mm/inch)	Size	Code	Quantity Per carton
330/12.99	10×20	80046	25

**HP-48-1**

8 Ball slopping hook for rectangular tube

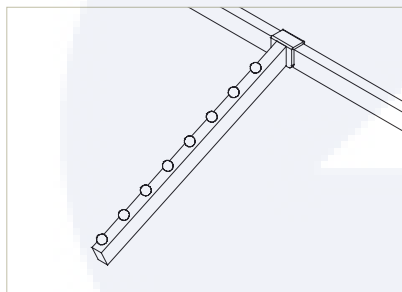
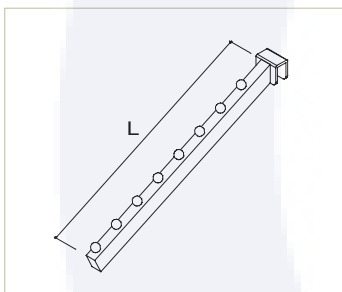

Length(mm/inch)	Size	Code	Quantity Per carton
330/12.99	12.9×25.5	80047	25

# Accessories



## NCC

Bracket clip

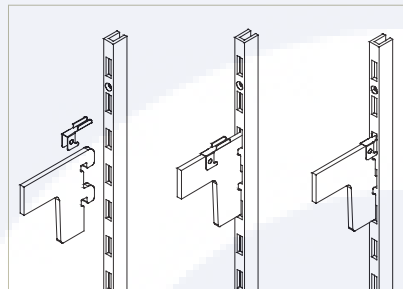
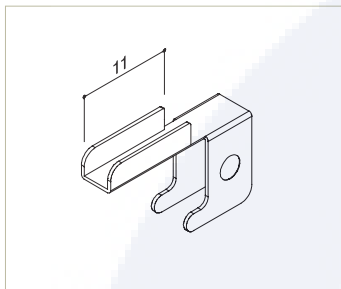

Length(mm/inch)	Actual size	Code	Quantity Per carton
11/0.43	11	81661	10

For the use with N-11, N-14, N-112, N-142.  
Bracket fastener(브라켓 잠금장치)

## NSC

Bracket clip

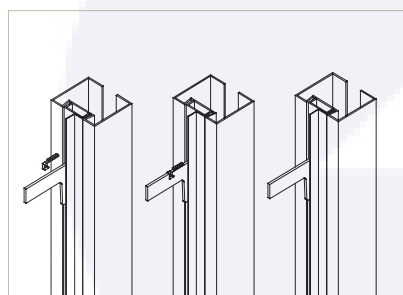
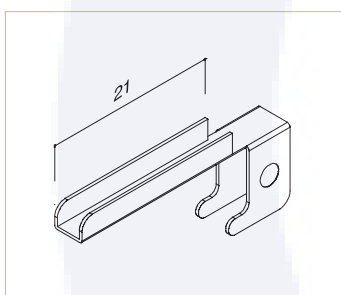

Length(mm/inch)	Actual size	Code	Quantity Per carton
21/0.82	21	81662	100

For the use with NSI-1, NC-R.  
Bracket fastener(브라켓 잠금장치)

## NF-01

Panel clip

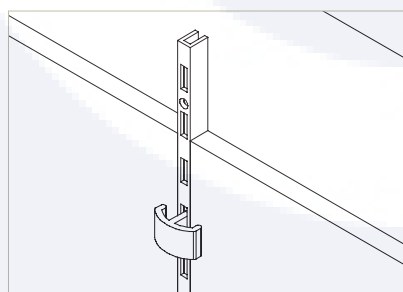
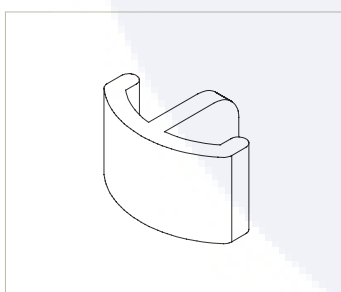

Size	Code	Quantity Per carton
W25 x H17	81681	50

For the use with N-11, N-14

## NF-02

Panel clip for recessed standards

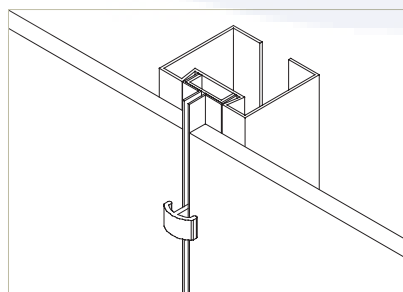
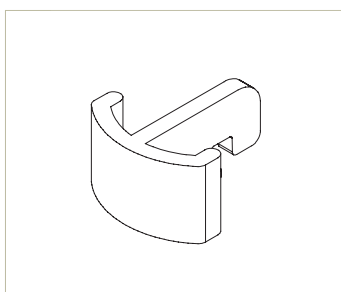

Size	Code	Quantity Per carton
W25 x H17	81682	50

For the use with NSI-1

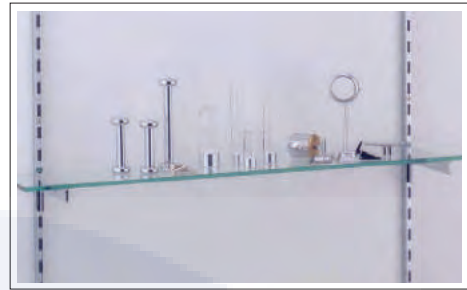

N-61

Round supporter

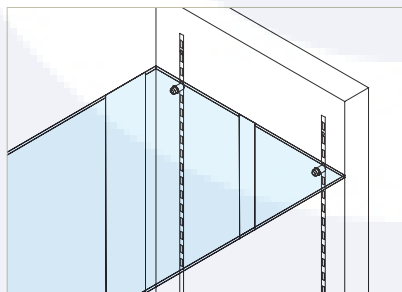
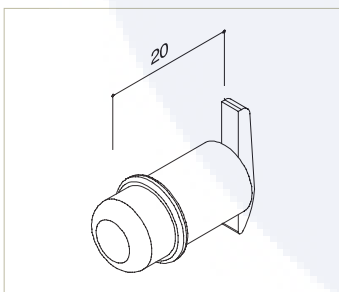

For the use with N-6, N-11 & N-1 (모든 채널에 사용가능)  
Suitable for all standards.

Length(mm/inch)		Code	Quantity Per carton
20/0.78		79910	50

N-62

Triangle supporter

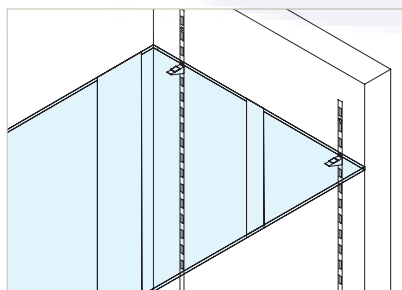
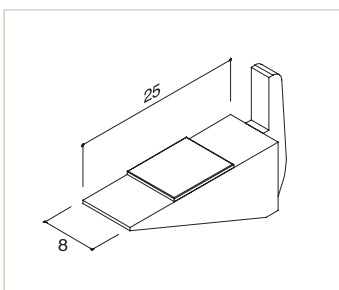

For the use with N-6, N-11 & N-1 (모든 채널에 사용가능)  
Suitable for all standards.

Length(mm/inch)		Code	Quantity Per carton
20/0.78		81631	50

**RSS-10** 보조받침대

Assistant strut

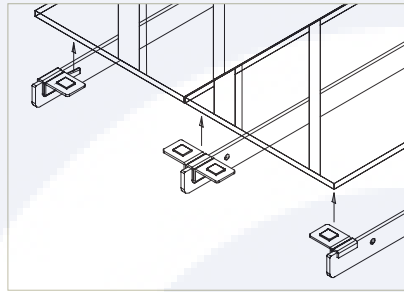
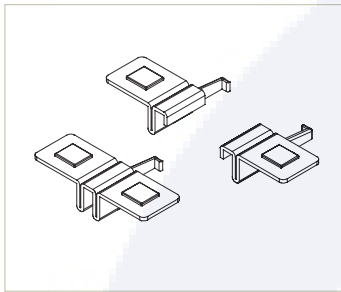

For the use with NX-22, NX-23, NX-24, NX-822

Type	Code	Quantity Per carton
L, R	79930	10 +10
Center	79932	20

**RSS-11** 보조받침대

Assistant strut

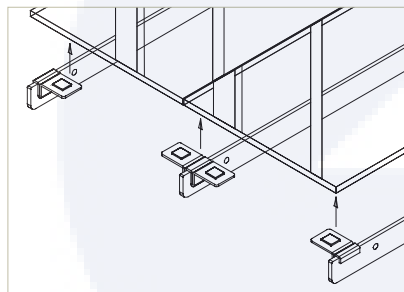
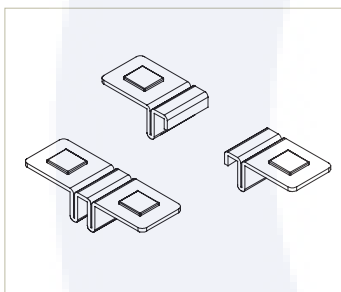

For the use with NX-533, NX-543

Type	Code	Quantity Per carton
L, R	79940	10 +10
Center	79942	20



### PB-12 L, R

Bracket for panels

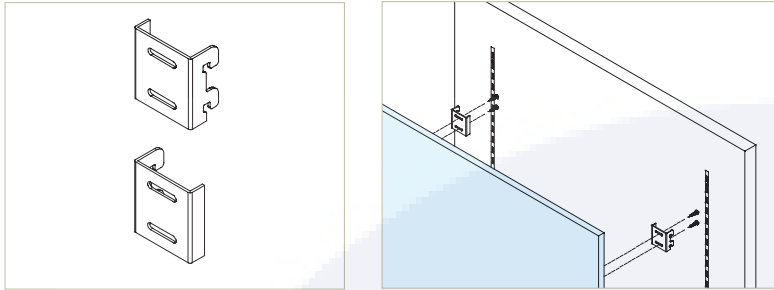

Type	Size	Code	Quantity Per carton
L, R	21	79920	5+5
L, R	31	79921	5+5

For attaching pannel(합판 부착용, MDF판넬 & 벽면판넬사용)

### PB-13

Bracket for panels

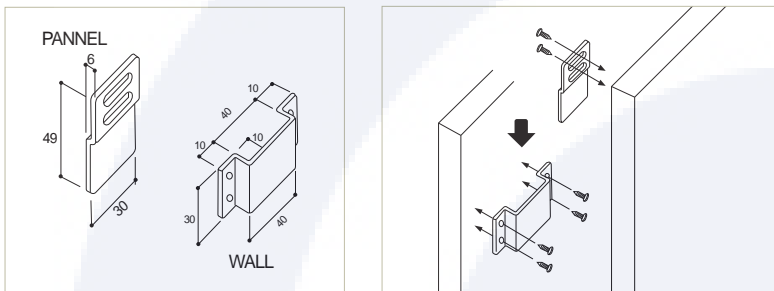

Type	Size	Code	Quantity Per carton
PANNEL	49×30	C003987	5+5
WALL	49×30		

For attaching pannel(합판 부착용, MDF판넬 & 벽면판넬사용)

### NC-01

Standards screw

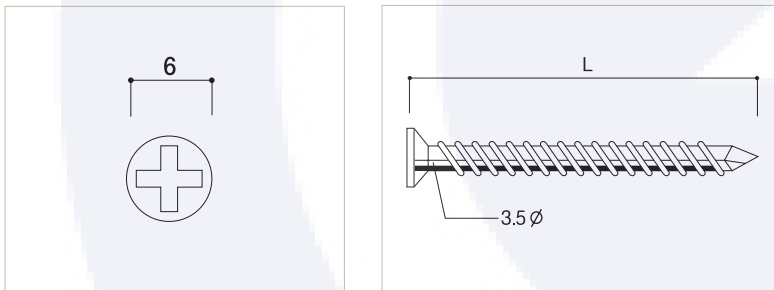

Length(mm/inch)	Actual size	Code	Quantity Per carton
20/0.78	20	80060	1000
30/1.18	30	80061	1000
35/1.37	35	80062	1000
40/1.57	40	80063	1000

MEMO



Neo fix



► Packing of Neo fix  
Upright Channel

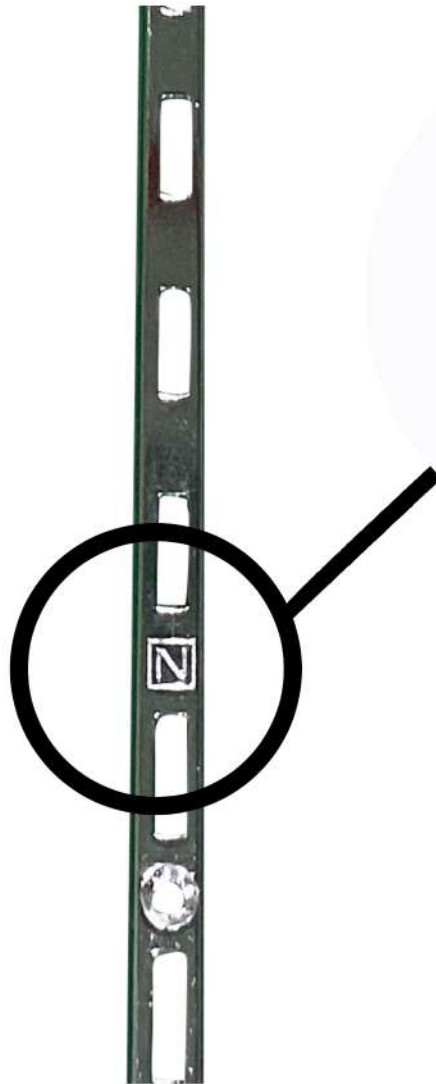

*Neo fix*  
The symbol of quality



**Registered Office:**

**GLOCHAR L.L.C.** D11,B2, Shams, UAE.

**Sales Office:**

M-8, Mezzanine Floor, Royal House Building – A Block, Near ADIB Bank, Al Wuheida St, Hor Al Anz East, P.O.Box: 93620, Dubai – UAE.

**(M)** +971 56 6822933 / +971 56 682 3325 **(W)** [www.glochar.com](http://www.glochar.com) **(E)** [info@glochar.com](mailto:info@glochar.com) | **Sales Enquiry:** [sales@glochar.com](mailto:sales@glochar.com)

